

RFC Editor Tutorial

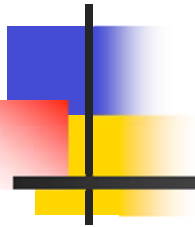

IETF 71

Philadelphia, Pennsylvania

9 March 2008



Overview of this Tutorial

1. Background: The RFC Series and the RFC Editor
2. The Publication Process
3. Contents of an RFC
4. How to Write an RFC
5. Conclusion



1. The RFC Series

- Earliest document series to be published online.
 - 1969 – today: 39 years old.
 - 5000+ documents.
- *An ARCHIVAL series: RFCs are forever!*
- A comprehensive record of Internet technical history



RFCs

- RFC document series
 - Begun by Steve Crocker [RFC3] and Jon Postel in 1969
 - Informal memos, technical specs, and much more.
- Jon Postel quickly became *the* RFC Editor.
 - 28 years: 1970 until his death in 1998.
 - He established and maintained the consistent style and editorial quality of the RFC series.
 - Jon was a 2-finger typist.

Jon Postel

Jon Postel had an enormous influence on the developing ARPAnet & Internet protocols – the “Protocol Czar” and the “Deputy Internet Architect” as well as the IANA and RFC Editor.

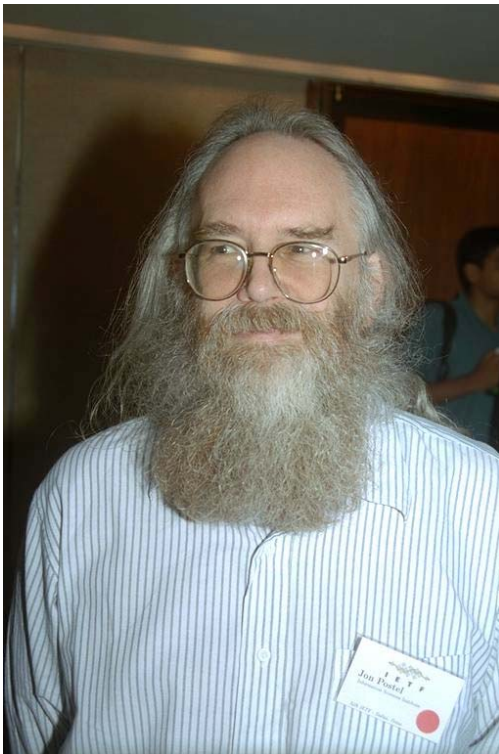
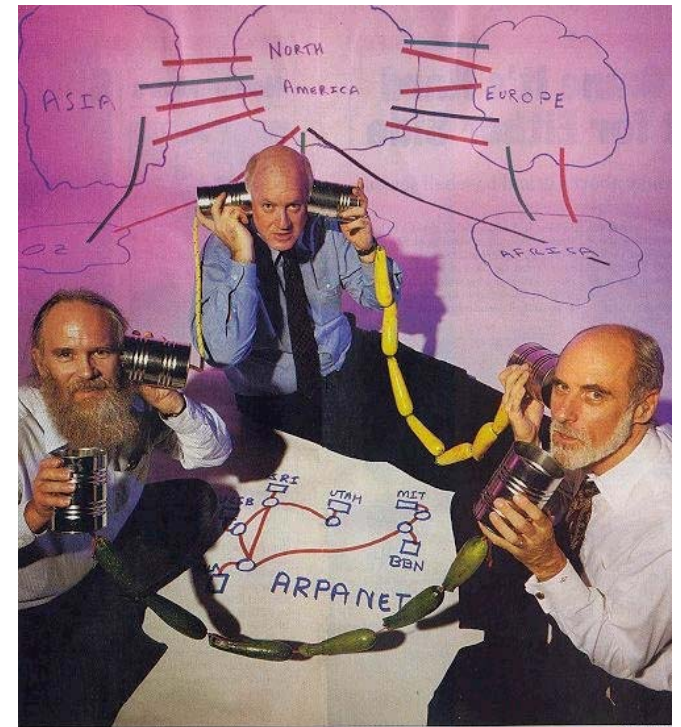

Photo by Peter Lothberg – IETF34 Aug 1995



Newsweek Aug 8, 1994

Historical Context of RFC Series

- 1969: Building ARPAnet RFC 1
- 1975: TCP/IP research begun ~RFC 700
 - Recorded in separate IEN series
- 1983: Internet born 1 Jan ~RFC 830
- 1985: IETF created ~RFC 950
- 1993: Modern IESG/IAB org ~RFC 1400
- 1998: Postel passed away ~RFC 2430
- Today ~RFC 5100

RFC Publication Rate

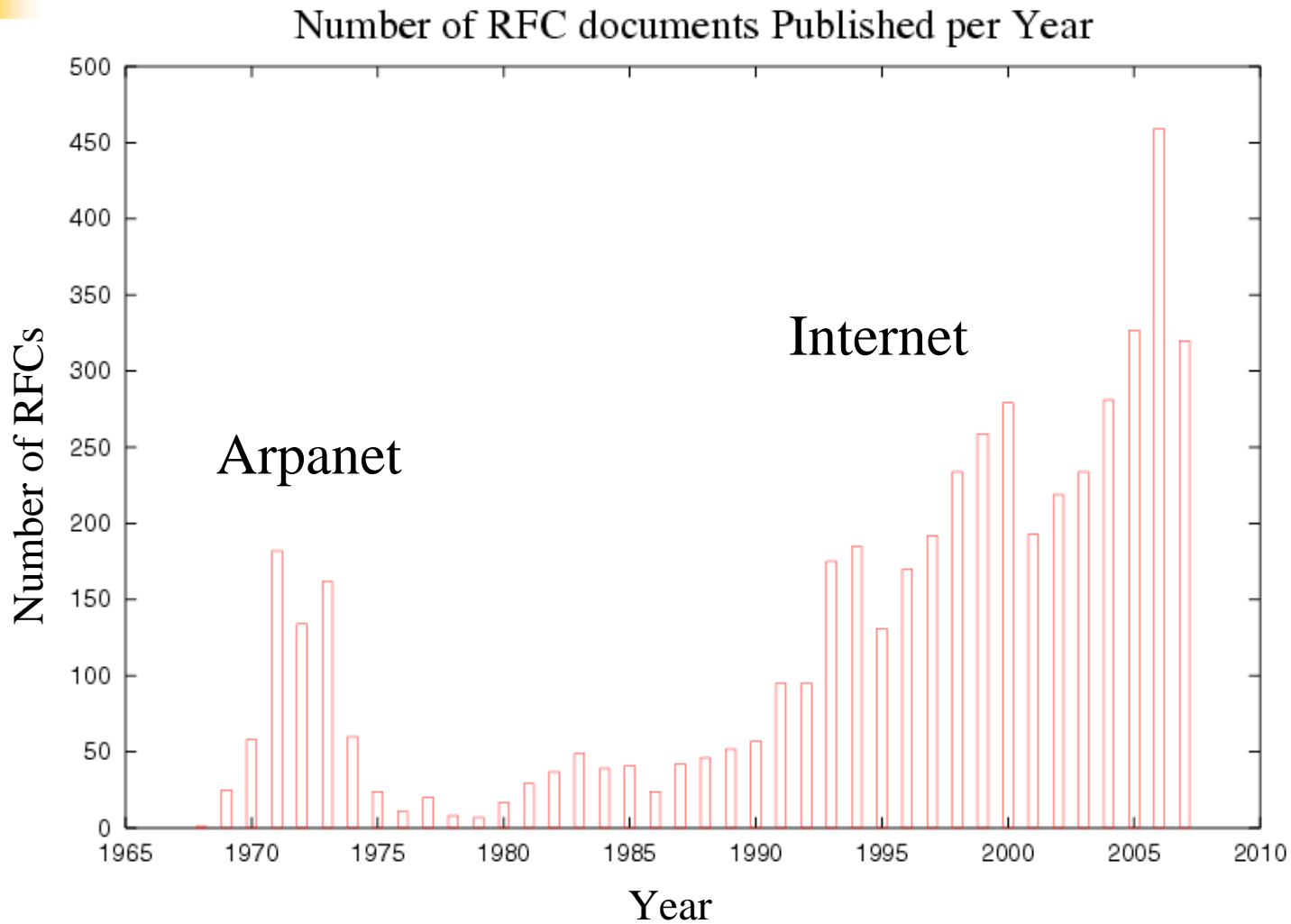



Jon Postel's Playful Side

- April 1 RFCs
 - A little humorous self-parody is a good thing...
 - Most, but not all, April 1 RFCs are satirical documents.
 - We expect you can tell the difference ;-)
- April 1 submissions are reviewed for cleverness, humor, and topical relation to IETF themes.
 - Avian Carriers is famous [RFC1149]
 - Evil Bit is a favorite [RFC3514]



The RFC Editor today

- A small group at Jon's long-term home,
 - the Information Sciences Institute (ISI) of USC.
 - ~6 FTEs
- Under contract with ISOC/IASA
- Current leadership:
 - Bob Braden, colleague of Postel 1970-1998.
 - Sandy Ginoza, editor of RFCs for 8 years.
- RFC Editorial Board
 - Provides advice and counsel to the RFC Editor, particularly about independent submissions.



The RFC Editor Web Site

<http://www.rfc-editor.org>

- Search engines for RFCs, Internet Drafts
- RFC publication queue
- Master index of RFCs
 - <ftp://ftp.rfc-editor.org/in-notes/rfc-index.txt>, .xml
- “Official Internet Protocols Standards” list
- Policy changes, news, FAQ, and more
- Errata



RFCs and the IETF

- It was natural to adapt the existing RFC series to publication of Internet standards specifications.
 - Informally: mid 1980s
 - Formally: RFC 1602 (1994), RFC 2026 (1996)



RFC Categories

- RFC 2026 defines specification **maturity levels**:
 - Standards track: Proposed, Draft, Standard.
 - Non-standards track: Experimental, Informational, Historic.
 - "Almost standard": Best Current Practice.
- Shown on RFC header as "**Category**:"
 - Except, one category "Standards Track" for PS, DS, S.
 - Often called "status".
- A published RFC can NEVER change, but its *category* can change (see rfc-index.txt).



Sources for RFCs

- IETF submissions
 - Mostly from Working Groups.
 - Rest are *individual* submissions via the IESG.
 - All are submitted to the RFC Editor by the IESG after approval process [RFC2026].
- IAB submissions
 - Submitted directly by IAB Chair
 - Informational category
- RFC Editor (*independent*) submissions
 - Only Experimental or Informational category.
- IRTF submissions

AD-sponsored (Individual)

RFC Editor (Independent)

Post as an Internet-Draft.

- Contact the relevant AD.
- Standards Track, Experimental, or Informational category.
- See ION
<http://www.ietf.org/IESG/content/ions/ion-ad-sponsoring.html>

- Contact the RFC Editor.
- RFC Editor reviews and decides whether publication is appropriate.
- IESG reviews for conflict with any WG, makes publish/do-not-publish recommendation.
- RFC Editor has final decision, with advice from Editorial Board.
- Only Experimental or Informational category.
- See www.rfc-editor.org/indsubs.html and RFC 4846.

For a discussion of when a document cannot be processed as an independent submission, see RFC 3932.



Review of Independent Submissions

- RFC Editor finds competent reviewer(s), with advice and aid from the Editorial Board.
- Possible conclusions:
 - Out of scope for RFC series.
 - Incompetent or redundant, not worth publication.
 - Important, but should go through IETF process first ("Throw it over the wall to the IESG!")
 - Serious flaws – report to author, reject for now.
 - Suggest changes to author, then OK to publish.
 - Great! Publish it.
- See www.rfc-editor.org/indsubs.html and RFC 4846 for more info



RFC Sub-Series

- All RFCs are numbered sequentially.
- There was a desire to identify significant subsets of RFCs, so Postel invented “**sub-series**”. An RFC may have a sub-series designator.
 - e.g., “RFC 2026, BCP 9”
- Sub-series designations:
 - BCP Best Current Practice category
 - STD Standard category
 - FYI Informational category: user documentation



STD Sub-Series

- Originally: all protocol specs were expected to quickly reach (full) Standard category.
 - Then the STD sub-series would include all significant standards documents.
 - Of course, it did not work out that way; most standards-track documents do not get beyond Propose Standard.
 - See "Official Internet Protocol Standards"
 - See: www.rfc-editor.org/rfcxx00.html for the REAL list of current relevant standards-track docs.

STD Sub-Series

- STDs were overloaded to represent “complete standards”; one STD # can contain multiple RFCs.
- Examples:
 - STD 5 = “IP”, includes RFCs 791, 792, 919, 922, 950, 111
NB: When multiple RFCs make up a sub-series doc (for example, <ftp://ftp.rfc-editor.org/in-notes/std/std5.txt>) the file starts with
[Note that this file is a concatenation of more than one RFC.]
 - STD 13 = “DNS”, includes RFCs 1034, 1035
 - STD 12 = “Network Time Protocol”, currently no RFCs.



STDs as Protocol Names

- Really, "RFCxxxx" is only a *document name*.
 - But, people often talk about "RFC 821" or "821" when they mean "SMTP".
- As protocols evolve, RFC numbers make confusing names for protocols. Postel hoped that STD numbers would function as protocol names.
 - But reality is too complicated for this to work well.
 - It HAS been working for BCPs.
- We need a better way to name protocols.
 - ISD (Internet Standards Document) proposal?



Overview of this Tutorial

1. Background: The RFC Series and the RFC Editor
2. The Publication Process
3. Contents of an RFC
4. How to Write an RFC
5. Conclusion

Overview from the Authors' Perspective

- Step 0: Write an Internet-Draft.
 - IESG approval -> your document is added to the queue
- Step 1: Send your source file.
 - questions from the RFC Editor
- Step 2: Answer questions.
 - AUTH48 notification with a pointer to the edited version
- Step 3: Review your document carefully and send changes / approvals for publication.
- Step 4: See your document progress.
- Step 5: Publication!

Step 0: Write an Internet-Draft

- A well-formed RFC starts with a well-formed I-D.
 - <http://www.ietf.org/ID-Checklist.html>
 - <http://www.ietf.org/ietf/1id-guidelines.txt>
- Authoring tools
 - <http://www.rfc-editor.org/formatting.html>
 - <http://tools.ietf.org/inventory/author-tools>
 - More on this later.

A Generic Case: draft-ietf-wg-topic-05

Let's say your document has been approved by the IESG...

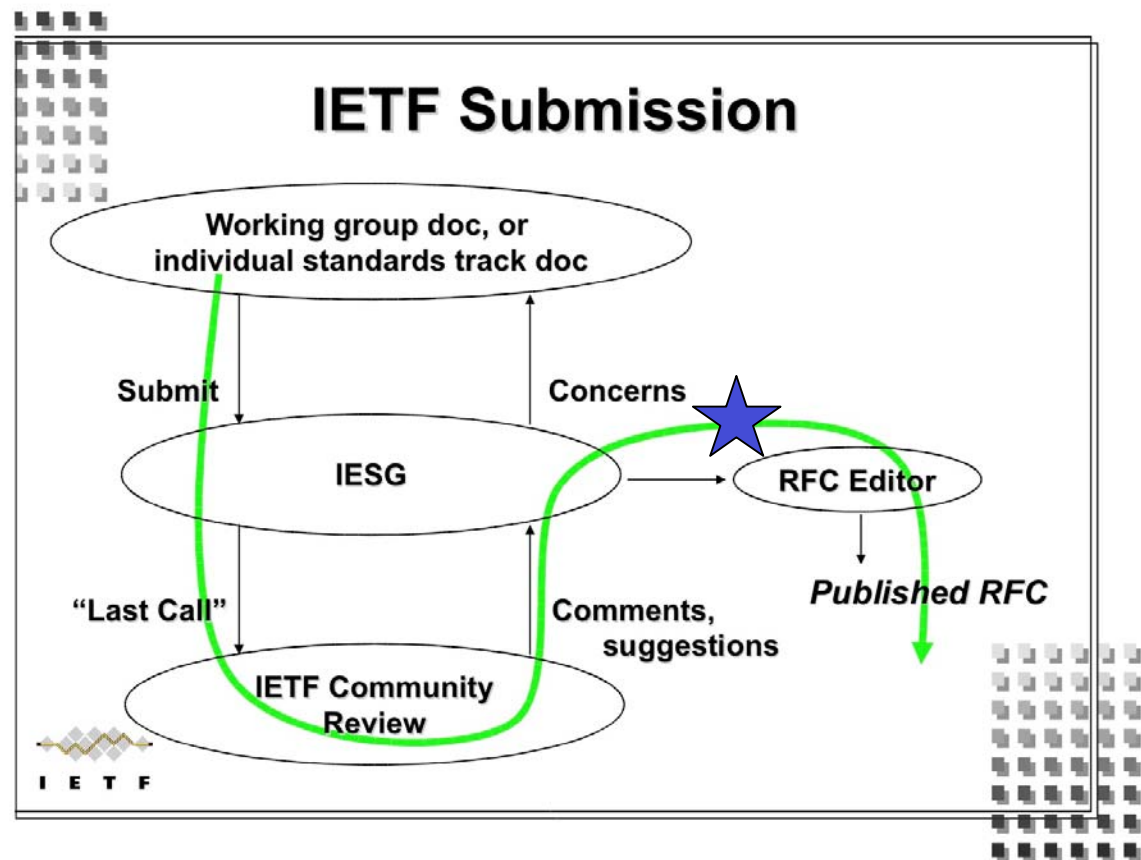

figure from Scott Bradner's Newcomer Presentation

Step 1: Send your source file.



From: rfc-editor@rfc-editor.org

Subject: [RFC State] <draft-ietf-wg-topic-05> has been added to RFC Editor database.

- Your document has been added to the queue (www.rfc-editor.org/queue.html).
- Please send us your nroff or xml source file.
 - Let us know if there are any changes between the version you send and the IESG-approved version.
- If you don't have one, don't worry, we will use the Internet-Draft text to create an nroff file.

Step 2: Answer questions.



From: rfc-editor@rfc-editor.org or *@isi.edu
Subject: draft-ietf-wg-topic-05

- Please reply to questions about your draft. Typically, these questions are about
 - missing citations
 - Ex: [RFC4301] appears as a normative reference, where would you like to cite it in the text?
 - inconsistent terminology
 - Ex: Which form of the term should be used throughout?
RESTART Flag / Re-Start flag / Restart Flag
 - unclear sentences

Step 3: See your document progress.



From: rfc-editor@rfc-editor.org

Subject: [RFC State] <draft-ietf-wg-topic-05> has changed state

Basic Process

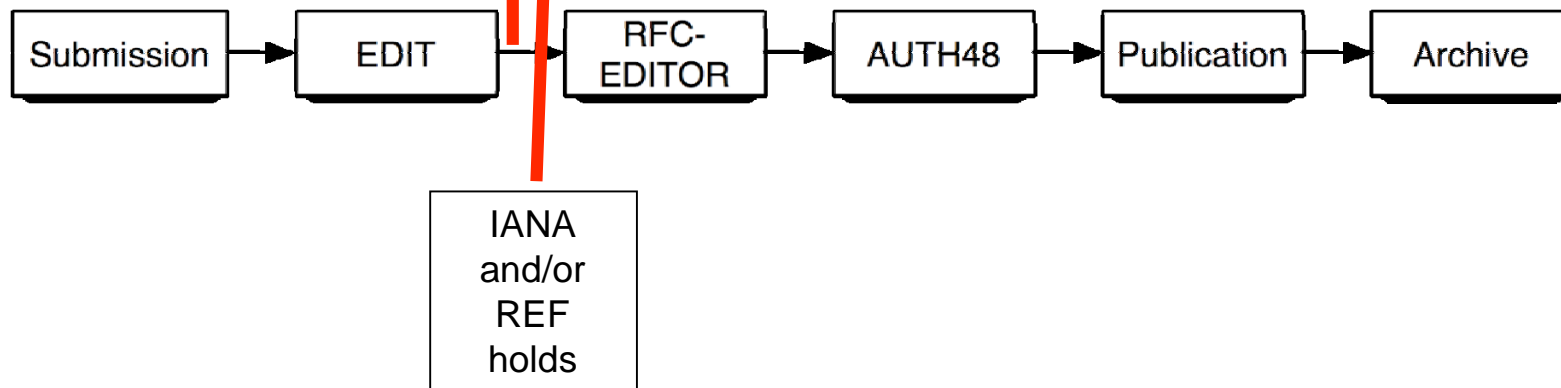

Also, you can check <http://www.rfc-editor.org/queue.html>



More details on queue states

Normative References

- Set of RFCs linked by normative refs must be published simultaneously.
- Two hold points:
 - MISSREF state: a doc with norm. ref to a doc not yet received by RF Editor.
 - REF state: a doc that is edited but waiting for dependent docs to be edited.

IANA

- Acts on IANA Considerations section (more on this later).
- Creates new registries and assigns numbers.

Step 4: Review your document carefully



From: rfc-editor@rfc-editor.org

Subject: AUTH48 [SG]: RFC 4999 <draft-ietf-wg-topic-05>

- This is your chance to review the edited version.
- We send pointers to the txt and diff files
 - and the XML file (when AUTH48 in XML)
- Submit changes by sending OLD/NEW text or indicating global changes.
 - Insert directly into the XML file (when AUTH48 in XML)
- Each author listed on the first page must send their approval before the document is published.

More about AUTH48: Final Author Review



- Last-minute editorial changes allowed – But should not be substantive or too extensive.
 - Else, must get OK from AD, WG chair.
- This process can involve a fair amount of work & time
 - AT LEAST 48 hours!
 - All listed authors must sign off on final document
 - Authors should take it seriously - review the entire document, not just the diffs.
 - Your last chance to avoid enrollment in the *Errata Hall of Infamy!*

Step 5: Publication!

- Announcement sent to lists:
ietf-announce@ietf.org and rfc-dist@rfc-editor.org
- Canonical URI:
<http://www.rfc-editor.org/rfc/rfcXXXX.txt>
- Also available here:
<ftp://ftp.rfc-editor.org/in-notes/rfcXXXX.txt>
- Mirrored at IETF site and other sites.
- NROFF and XML source files archived for later revisions.

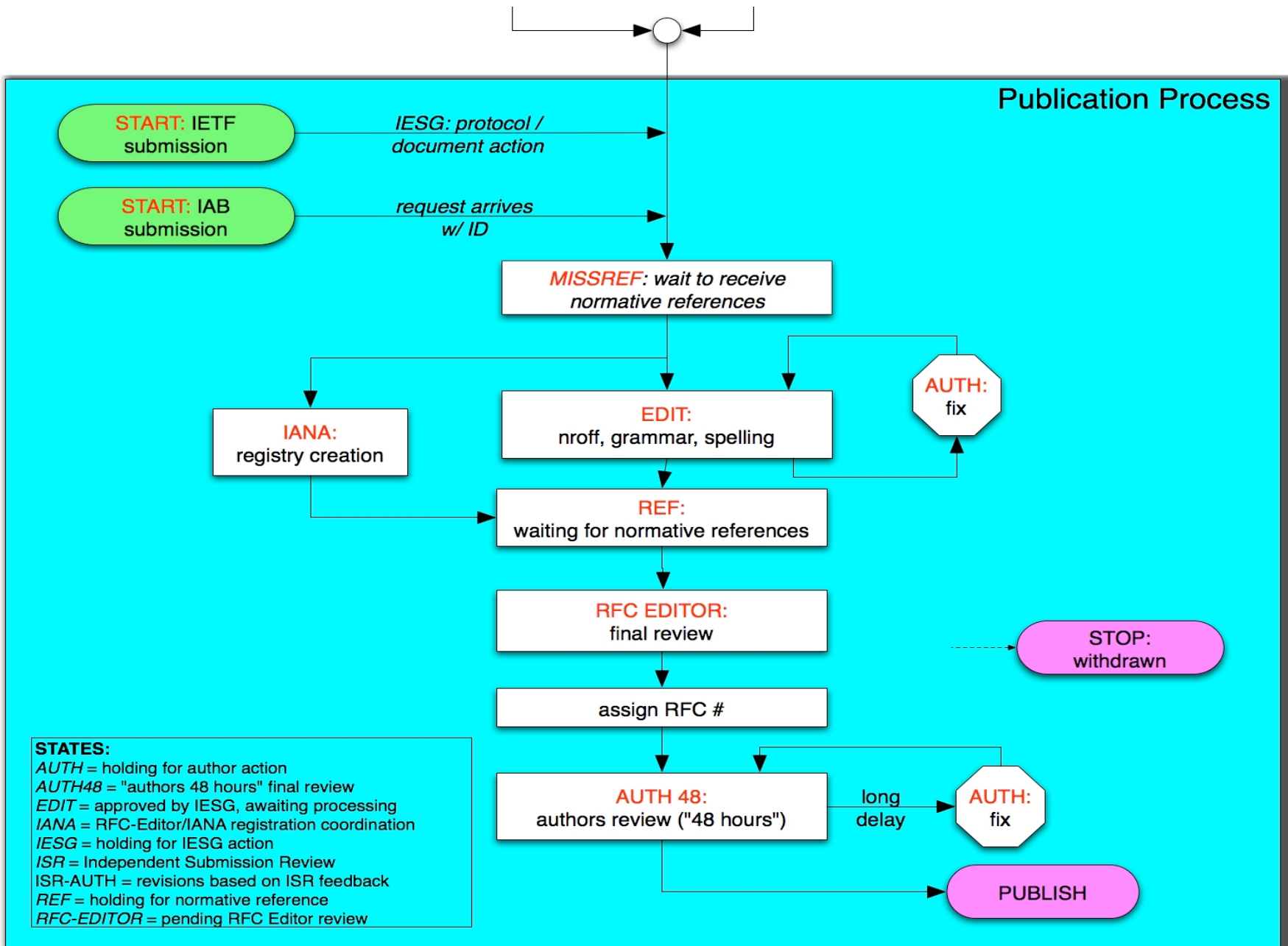

Aaron Falk November 1, 2005, v.15



Errata Page

- www.rfc-editor.org/errata.php
 - A list of technical and editorial errors that have been reported to the RFC Editor.
 - Verified by the authors and/or the IESG, unless marked "Reported".
 - The RFC Editor search engine results contain hyperlinks to errata, when present.
- How to report errata
 - Use the online form available from the errata page



Overview of this Tutorial

1. Background: The RFC Series and the RFC Editor
2. The Publication Process
3. Contents of an RFC
4. How to Write an RFC
5. Conclusion



3. Contents of an RFC

- Header
 - Title
 - Header boilerplate (Status of Memo)
 - IESG Note (when requested by IESG)
 - Abstract
-
- Table of Contents (not required for short docs)
 - Body
 - Authors' Addresses
-
- IPR boilerplate
 - See RFC 3667/BCP 78, RFC 3668/BCP 79.

RFC Header

Network Working Group
Request for Comments: 3986
STD: 66
Updates: 1738
Obsoletes: 2732, 2396, 1808
Category: Standards Track

T. Berners-Lee
W3C/MIT
R. Fielding
Day Software
L. Masinter
Adobe Systems
January 200

- STD sub-series number 66
- Updates, Obsoletes: relation to earlier RFCs.
 - Please note this information in a prominent place in your Internet-Draft; preferably the header.

RFC Header: Another Example

```
Network Working Group
Request for Comments: 2396
Updates: 1808, 1738
Category: Standards Track
```

```
T. Berners-Lee
MIT/LCS
R. Fielding
U. C. Irvine
L. Masinter
Xerox Corporation
August 1998
```

Corresponding RFC Index entry (search on "2396")

RFC2396	T. Berners-Lee, R. Fielding, L. Masinter	August 1998	ASCII	Obsoleted by RFC3986, Updates RFC1808, RFC1738, Updated by RFC2732 Errata	DRAFT STANDARD
---------	--	----------------	-------	---	---------------------------

Red fields were not known when RFC was published

Authors in Header



- Limited to lead authors, document editors.
- There must be very good reason to list more than 5.
- Each author in the header must give approval during AUTH48 review.
- Each author in the header should provide unambiguous contact information in the Authors' Addresses section.
- Other names can be included in Contributors and/or Acknowledgments sections.

Titles



- Should be thoughtfully chosen
- No un-expanded abbreviations - except for very well-known ones (e.g., IP, TCP, HTTP, MIME, MPLS)
- We like short, snappy titles, but sometimes we get titles like:
 - *“An alternative to XML Configuration Access Protocol (XCAP) for manipulating resource lists and authorization lists, Using HTTP extensions for Distributed Authoring and Versioning (DAV)”*

Abstracts

- Carefully written for clarity (*HARD* to write!)
- No un-expanded abbreviations (again, except well-known)
- No citations
 - Use “RFC xxxx”, not “[RFCxxxx]” or “[5]”
- Less than 20 lines! Shorter is good.
- **Not a substitute for the Introduction;** redundancy is OK.
- We recommend starting with “This document...”



Body of an Internet-Draft

- First section should generally be “1. Introduction”.
- Special sections that may appear:
 - Contributors, Acknowledgments
 - Internationalization Considerations
 - When needed -- see Section 6, RFC 2277/BCP 18.
- Sections that **MUST** appear:
 - IANA Considerations
 - Security Considerations
 - References (Normative and/or Informative)



Security Considerations Section

- Security Considerations section **required** in every RFC.
- See [RFC 3552](#): “Guidelines for Writing RFC Text on Security Considerations”
- Important!

IANA Considerations Section



- What is an IANA Considerations section?
 - A guide to IANA on what actions will need to be performed
 - A confirmation if there are NO IANA actions
- Section is required in draft
 - But “No IANA Considerations” section will be removed by RFC Editor.



Why is this section important?

- Forces the authors to 'think' if anything should be requested from IANA
- A clear IANA Considerations section will allow the IANA to process the IANA Actions more quickly
- Establishes documented procedures

What should be included in the IANA Considerations section?



- What actions is the document requesting of IANA
- Individual number or name registrations
- New registries (number or name spaces)
- Registration procedures for new registries
- Reference changes to existing registrations

BE CLEAR AND DESCRIPTIVE IN YOUR INSTRUCTIONS
(IANA is not the expert for your name or number space)



Review of IANA Considerations

- IANA Consideration sections are reviewed before the document is published as an RFC
 - During IESG Last Call
 - During IESG Evaluation
 - IANA will also review your section at any time by request
- If you do not have an IC section or if your IC section is not complete, your document will not move forward



Where to get help on writing this section

- See RFC 2434, “Guidelines for Writing an IANA Considerations Section in RFCs”
 - Soon to be replaced by RFC2434bis
- Look at existing registries for examples
- Ask IANA
 - Available at the IANA booth at IETF meetings
 - Send an e-mail [iana@iana.org] or [michelle.cotton@icann.org]

References



- Normative vs. Informative
 - Normative refs can hold up publication.
- We **STRONGLY** recommend against numeric citations "[37]".
- Citations and references must match.
- Handy file of RFC reference text:
 - <ftp://ftp.rfc-editor.org/in-notes/rfc-ref.txt>
- Include draft strings of any I-Ds.

Copyrights and Patents



- Copyright Issues
 - Specified in [RFC 3977/BCP 77](#) “IETF Rights in Contributions”
 - Independent submissions: generally follow IETF rules
- Patent (“IPR”) issues
 - RFC boilerplate specified in [RFC 3978/BCP 78](#) “Intellectual Property Rights in IETF Technology”
 - Recently updated by [RFC 4748/BCP 78](#).
- Generally, you supply the correct boilerplate in the Internet Draft, and the RFC Editor will supply the correct boilerplate in the RFC.



Overview of this Tutorial

1. Background: The RFC Series and the RFC Editor
2. The Publication Process
3. Contents of an RFC
4. How to Write an RFC
5. Conclusion

4. How to Write an RFC

- Some editorial guidelines
- Improving your writing
- Preparation tools
- MIBs and formal languages

“Instructions to Request for Comments (RFC) Authors”. draft-rfc-editor-rfc2223bis-08.txt aka

<ftp.rfc-editor.org/in-notes/rfc-editor/instructions2authors.txt>

General Editorial Guidelines

- Immutability – once published, never change
- Not all RFCs are standards
- All RFCs in English
 - RFC 2026 allows translations
 - British English is allowed in principle, but there is some preference for American English.
- Consistent Publication Format
 - ASCII (also .txt.pdf for Windows victims)
 - Also .ps or .pdf (special process for handling)



RFC Formatting Rules

- ASCII, 72 char/line.
- 58 lines per page, followed by FF (^L).
- No overstriking or underlining.
- No “filling” or (added) hyphenation across a line.
- <.><sp><sp> between sentences.
- No footnotes.



RFC Editing

- For correct syntax, spelling, punctuation: always.
 - Sometimes exposes ambiguities
- To improve clarity and consistency: sometimes.
 - e.g., expand each abbreviation when first used.
- To improve quality of the technical prose: occasionally.
- By general publication standards, we edit lightly.
 - Balance: author preferences against consistency and accepted standards of technical English.



Preserving the Meaning

- A comment that does not faze us:
“How dare you change my perfect prose?”
 - Just doing our job as editors!
- A comment that concerns us very much:
“You have changed the meaning of what I wrote”
 - Often, because we misunderstood what you meant.
 - That implies that your prose is ambiguous.
 - You should recast the sentence/paragraph to make it clear and unambiguous, so even the RFC Editor cannot mistake the meaning. ;-)



The RFC Editor checks many things

- Header format and content
- Title format
- Abstract length and format
- Table of Contents
- Presence of required sections
- No uncaught IANA actions
- Spelling checked
- ABNF/MIB/XML OK, using algorithmic checker
- Citations match references
- Most recent RFC/I-D cited
- Pure ASCII, max 72 char lines, hyphens, etc.
- Header and footer formats
- Page breaks do not create “orphans”
- References split into Normative, Informative
- Boilerplate OK

Writing RFCs

Not *literary* English, but *comprehensibility* would be nice!

- Avoid ambiguity.
- Use consistent terminology and notation.
 - If you choose “4-bit”, then use it throughout (not “four bit”).
- Define each term at first use.
- Expand every abbreviation at first use.
- See the abbreviations and terms lists available from <http://www.rfc-editor.org/howtopub.html>

Style



- Primary goal: **clear, unambiguous technical prose.**
- The RFC Editor staff generally follows two sources for style advice:
 - Strunk & White (4th Ed., 2000)
 - "A Pocket Style Manual" by Diana Hacker (4th Ed., 2004)
- **In any case, internally consistent usage is objective.**
- See the RFC style guide available from <http://www.rfc-editor.org/howtopub.html>



Sentence Structure

- **Simple declarative sentences** are good.
 - Flowery, literary language is not good.
 - Goal: Simple descriptions of complex ideas.
- Avoid long, involuted sentences. You are not James Joyce.
 - Use “;” | “, and” | “, or” sparingly to glue successive sentences together.
- Make parallel clauses parallel in syntax.
 - Bad: “... whether the name should be of fixed length or whether it is variable length”.

Grammar Tips

- Avoid passive voice (backwards sentences).
 - “In this section, the network interface is described.”
vs. “This section describes the network interface.”
- Some Protocol Engineers over-capitalize Nouns.
- “which” vs. “that”
For example:
 - (non-restrictive which: all RST attacks rely on brute-force)
 - **It should be noted that RST attacks, which rely on brute-force, are relatively easy to detect at the TCP layer.**
 - (restrictive that: only *some* RST attacks rely on brute-force)
 - **It should be noted that RST attacks that rely on brute-force are relatively easy to detect at the TCP layer.**



Punctuation Conventions

- A comma before the last item of a series:
 - “TCP service is reliable, ordered, and full-duplex”
 - Avoids ambiguities, clearly shows parallelism.
- Punctuation outside quote marks:
“This is a sentence”{.|?|!}
 - To avoid computer language ambiguities.



Lean and Mean

- You often improve your writing by simply crossing out extraneous ~~extra~~ words.
 - Look at each sentence and ask yourself, “Do I need every word to make my meaning clear and unambiguous?”
 - English professors call it the “Lard Factor” (LF) [Lanham79]
 - *“If you’ve not paid attention to your own writing before think of a LF of $\frac{1}{3}$ to $\frac{1}{2}$ as normal and don’t stop revising until you’ve removed it.”* [Lanham79]

[Lanham79] Richard Lanham, “Revising Prose”, Scribner’s, New York, 1979.



A Real Example

"When the nature of a name is decided one must decide whether the name should be of fixed length or whether it is variable length." (25 words)

- A. "One must decide whether the length of a name should be fixed or variable." (14 words, LF = .44)
- B. "We may choose fixed or variable length for a particular class of name." (13 words)
- C. "A name may have fixed or variable length." (7 words, LF = .72)



Another Real Example

"One way to avoid a new administrative overhead would be for individuals to be able to generate statistically unique names." (20 words)

- A. "New administrative overhead can be avoided by allowing individuals to generate statistically unique names."
(14 words, LF = .30)
- B. "Allowing individuals to generate statistically unique names will avoid new administrative overhead."
(12 words, LF = .40)



Another (reality-based) Example

“This is the kind of situation in which the receiver is the acknowledger and the sender gets the acknowledgments.” (19 words)

- A. “An acknowledgment action is taking place from the receiver and the sender.” (11, LF=.42)
- B. “The receiver returns acknowledgments to the sender.” (7, LF=.63)



Another Real Example

“Also outside the scope are all aspects of network security which are independent of whether a network is a PPVPN network or a private network (for example, attacks from the Internet to a web-server inside a given PPVPN will not be considered here, unless the way the PPVPN network is provisioned could make a difference to the security of this server).”

- Two sentences!
- “make a difference to” -> “affect”

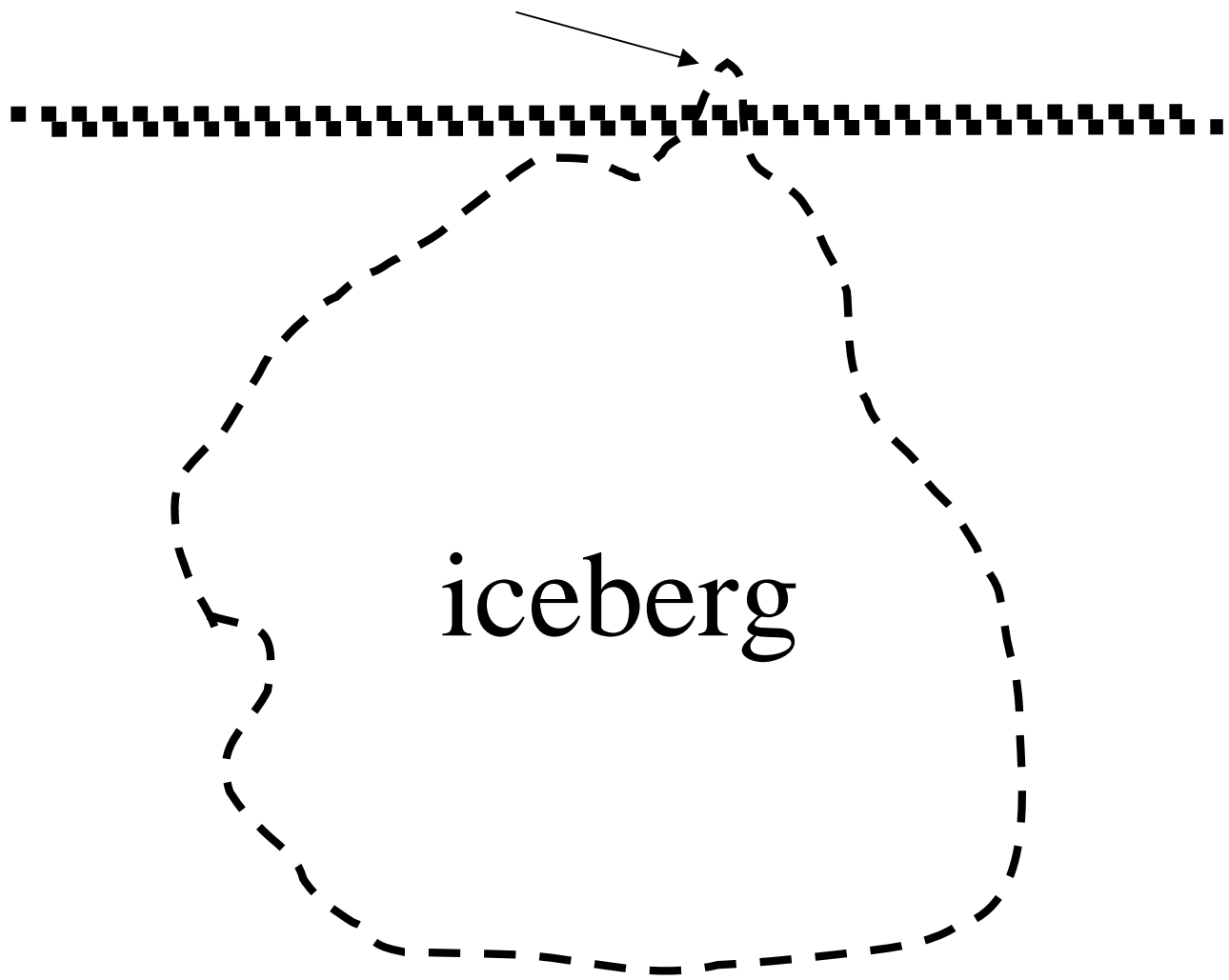



Format for Readability

- Careful use of indentation and line spacing can greatly improve readability.
 - Goes a long way to compensate for single font.
 - Bullets often help.
 - High density on a page may be the enemy of clarity and readability.
- The RFC Editor will format your document according to these guidelines, but it is helpful if you can do it in the I-D.



Hard to read

3.1 RSVP Message Formats

3.1.1 Common Header

The fields in the common header are as follows:

Flags: 4 bits

0x01-0x08: Reserved

No flag bits are defined yet.

Send_TTL: 8 bits

The IP TTL value with which the message is sent. See Section 3.8.



Formatted for Easier Reading

3.1. Message Formats

3.1.1. Common Header

The fields in the common header are as follows:

Flags: 4 bits

0x01-0x08: Reserved

No flag bits are defined yet.

Send_TTL: 8 bits

The IP TTL value with which the message is sent. See Section 3.8.

Text Formatting Tools



- Author tools: www.rfc-editor.org/formatting.html
 - xml2rfc
 - nroff
 - Microsoft word template
 - LaTeX
- RFC Editor does final RFC formatting using venerable Unix tool nroff -ms.

xml2rfc (<http://xml.resource.org>)

- The xml2rfc tool converts an XML source file to text, HTML, or nroff. RFC 2629 and its unofficial successor (<http://xml.resource.org/authoring/draft-mrose-writing-rfcs.html>) define the format.
- XML templates are available from <http://www.rfc-editor.org/formatting.html>:
 1. For a generic I-D (by Elwyn Davies)
 2. For an I-D containing a MIB (by David Harrington)

nroff, groff



- Handy templates for authors using nroff:
 - <ftp.rfc-editor.org/in-notes/rfc-editor/2-nroff.template>
 - Published in 1991 by J. Postel. Updated October 2006.
 - Gives instructions on using macros for creating RFCs.
 - www.1-4-5.net/~dmm/generic_draft.tar.gz
 - Updated nroff template maintained by David Meyer.
- If you use nroff `-ms` (without a private `make` file), give the nroff source to the RFC Editor.

MIB RFCs: A Special Case



- MIB references
 - O&M Web Site at www.ops.ietf.org/
 - MIB doctors at www.ops.ietf.org/mib-doctors.html
 - MIB Review: See RFC 4181, BCP 111: "Guidelines for Authors and Reviewers of MIB Documents"
- Tools
 - <http://www.ops.ietf.org/mib-review-tools.html>
 - smilint at www.ibr.cs.tu-bs.de/projects/libsmi/
 - SMICng at www.snmpinfo.com/
- MIB boilerplate
 - The Internet-Standard Management Framework:
www.ops.ietf.org/mib-boilerplate.html
 - Security Considerations: www.ops.ietf.org/mib-security.html

Use of Formal Languages



- Formal languages and pseudo-code can be useful as an aid in explanations, although English remains the primary method of describing protocols.
- Pseudo-code judged on the basis of clarity.
- Formal Languages (e.g., ABNF, XML, ASN.1 (MIBs))
 - Requires a normative reference to language specification
 - RFC Editor will run verifier program.
- www.ietf.org/IESG/STATEMENTS/pseudo-code-in-specs.txt
- [ftp.rfc-editor.org/in-notes/rfc-editor/UsingPseudoCode.txt](ftp://rfc-editor.org/in-notes/rfc-editor/UsingPseudoCode.txt)



Overview of this Tutorial

1. Background: The RFC Series and the RFC Editor
2. The Publication Process
3. Contents of an RFC
4. How to Write an RFC
5. Conclusion



5. Conclusion: Hints to Authors

- Read your I-D carefully **before** submission, as you would read the final document in AUTH48!
- Respond promptly to all messages from RFC Ed.
- If your I-D is in the queue, and you see typos or have a new email address, send us an email.
- DON'T use numeric citations (unless you submit an XML file)
- Avoid gratuitous use of requirement words (MUST, etc.)
- Craft title and abstract carefully.
- Remember that your document should be understandable by people who are not deep experts in the subject matter.



Ongoing Issues

- Normative references
 - Practical effect: can hold up publication
- MUST/MAY/SHOULD/... requirement words
 - Do they belong in Informational documents at all?
 - Tend to be overused or used inconsistently.
- URLs in RFCs
 - Some are more stable than others...
- *Updates* and *Obsoletes* relationships
 - Some disagreement on what they mean
 - At best, only high-order bit of complex relationship
 - RFC Editor hopes ISD (Internet Standard Document) [Newtrk] will be more systematic and complete.



Q: Why hasn't my document been published yet?

A: You can check the state of your document online at www.rfc-editor.org/queue.html

- "IANA" indicates waiting on IANA considerations
- "REF" indicates there are normative references
- "AUTH48" indicates each author must send final approval of the document



Q: What if one of the authors cannot be located during AUTH48?

A: You have several options:

- An AD can approve the document in place of the unavailable author. See <http://www.ietf.org/IESG/STATEMENTS/auth48-announcement.txt>
- The author can be moved to a Contributors or Acknowledgments section.

Authoritative References

- Overview of RFC publication:

www.rfc-editor.org/howtopub.html

- “Instructions to Request for Comments (RFC) Authors”. draft-rfc-editor-rfc2223bis-08.txt aka

[ftp.rfc-editor.org/in-notes/rfc-editor/instructions2authors.txt](ftp://ftp.rfc-editor.org/in-notes/rfc-editor/instructions2authors.txt)



The IETF Web Site & IETF Tools

<http://www.ietf.org>

- Working Group charters, mailing lists
- Meeting agendas and proceedings
- I-D Submission and I-D Tracker
- IESG actions

<http://tools.ietf.org>

- Tools for preparing drafts, viewing drafts, communicating, following IETF meetings

Thank you

Questions? Comments?

- Ask us now!
- IETF 71: Stop by the RFC Editor or IANA Desks.
- RFC Editor Interest List: rfc-interest@rfc-editor.org
- Email: rfc-editor@rfc-editor.org